

STING

Electromechanical automation for sliding gates
up to 3m - 400 kg



For residential and
collective usage



Available in 24V

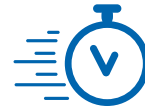

#fastasyoulike!
STING BOOST
gate opening at 90° in 9"



STING BOOST



Quick unlocking with customized metal key

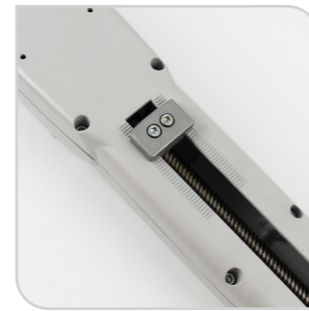

Get rid of ground stops by using the **mechanical stops** (optionals)

Robust and reliable operator, in one-piece body
Gate opening up to 110 °



No risk of gate block in case of blackout thanks to the **backup batteries** (optional) that can be installed on 24V models

The DE@NET universal control units make this engine **compatible with NETLINK** System.



Very adaptable during installation, thanks to the adjustable **fixing plates** (optional - art. MLS/SFR)



Fast maneuvering with **STING BOOST**: the new 24V model of the STING range with a minimum opening time of 90 ° in 9 seconds. Available in **kit**.



STING BOOST

Opening time about 90 °

9"

Note: the opening time may increase depending on the characteristics of the installation

KIT

Sting Boost Single Gate (Includes two remotes)
 Sting Boost Double Gate (Includes two remotes)

CODE

STINGBOOST-SINGLE
 STINGBOOST-DOUBLE

Technical info

TECHNICAL INFO	STING-BOOST
Motor power supply (V)	24V ~
Maximum power absorption (W)	85
Max thrust (N)	1000
Time with total stroke (s)	9
90° Opening time (s)*	9
Duty cycle (cycles/hours)	40
N. max cycles in 24h	90
Operating temperature (°C)	-20 ÷ 50
Sound pressure (dBA)	< 70
Protection level	IPX4

*the opening time of the leaf at 90° may be lower accordingly to the geometry of the installation

Generic accessories

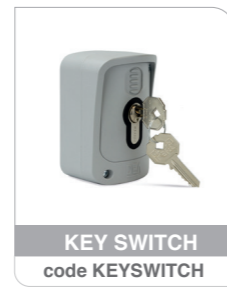
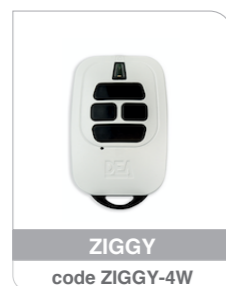
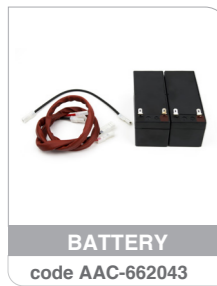

Dimensions

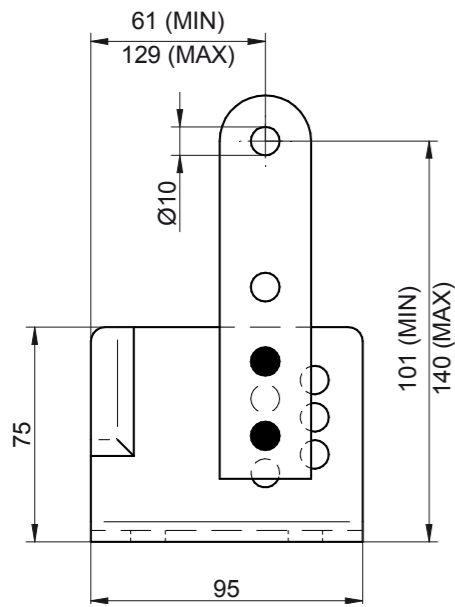
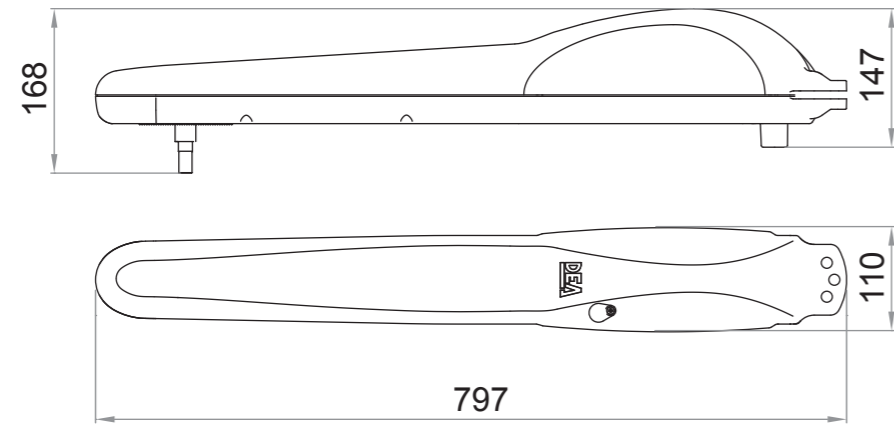

rear

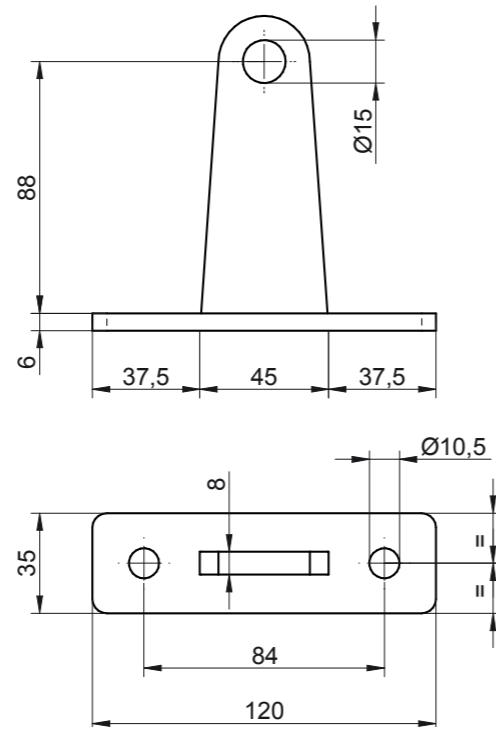

front

Installation dimensions

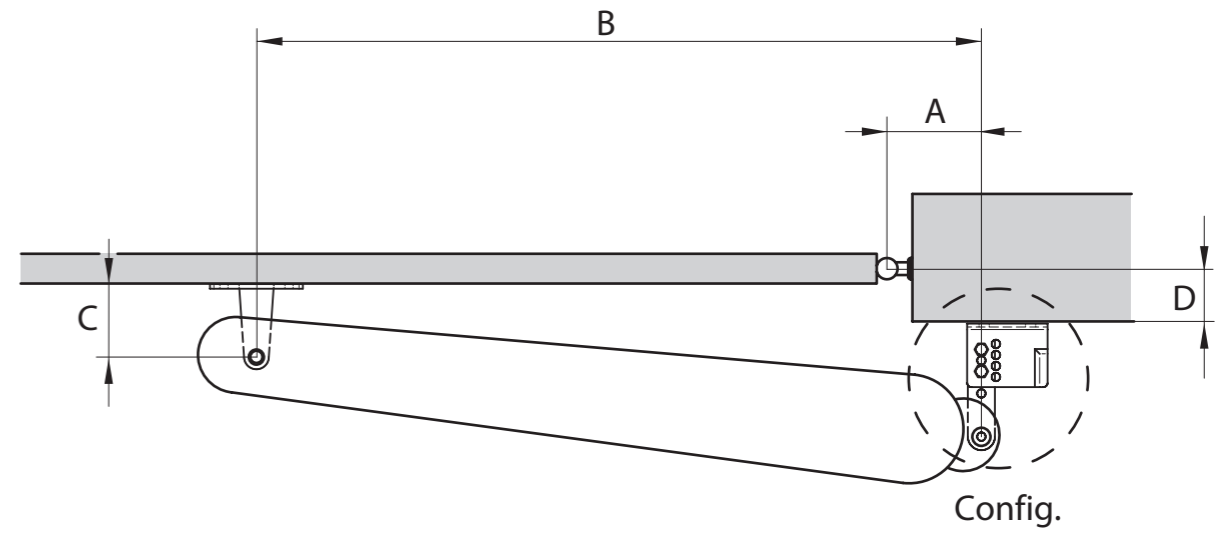

Art. STING	
Config. 1	Config. 2

STING						Note
	Config.	A	B	C	D	
90°	1	125	720	94	0÷50	
	2	125	715	94	50÷100	
	2	150	715	124	100÷125	
100°	1	160	720	104	0÷25	
	1	170	720	109	25÷50	
110°	1	185	720	99	0	
	2	185	720	99	25	

DEAuser



DEAuser is the app for the **private user** which allows you to control the DEA automation in **close proximity**.

By installing NET-NODE on all devices with NETLINK technology, you can control your gate through your smartphone.

To be used with:



NET-NODE



DEAinstaller



DEAinstaller is the App dedicated to the **professional installer** which allows you to program and manage DEA automations in a simple and intuitive way from your smartphone.

If you use it with NET-NODE you can:

- ✓ Keep a **data backup** of all your installations
- ✓ Easily adjust the **parameters** of your control boards
- ✓ Update the **firmware**
- ✓ Program the **maintenance**
- ✓ Manage or customize the **remotes**
- ✓ Read **technical manuals** or have a look at the **electrical connections**
- ✓ Control the **inputs** and **output** of the control boards
- ✓ **Control** the automation with the App

To be used with:



Art.NET-NODE
Cod.677640

